

EL PRIMA PRO



Victoria Arduino

INSPIRED BY YOUR PASSION.



ALONGSIDE PIONEERS

Get ready to reach new heights of quality, to discover new boundaries of taste and to savour the emotion of going where no-one has gone before.



ABSOLUTE PROFESSIONAL



WHERE ARE WE HEADED?

- • • E1 Prima PRO establishes a new paradigm for single groups.
- • • All standards are challenged and exceeded. This covers performance, control, extraction flexibility, lightness
- • • and compactness.



FROM TODAY, WE'RE READY TO GO BEYOND.

EJ PRIMA PRO

The most powerful Victoria Arduino single group ever made.

All in One

The latest generation of espresso and steam technology.

Absolute Control

T3 Genius: absolute control and extraction precision to obtain high-level performance in the cup.

Perfect Balance

Victoria Arduino performance and design for taste pioneers.



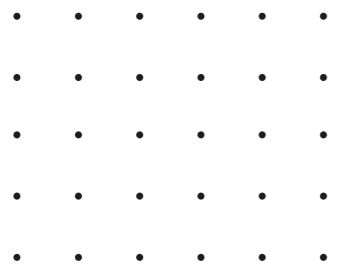

A POWERFUL ICON

Original Victoria Arduino style condensed to its essence and a look never seen before.



MADE BY PIONEERS FOR PIONEERS

- • • • • • • The Victoria Arduino laboratories have condensed the most advanced technology into the most eclectic form.
- • • • • • • A cutting-edge machine for coffee specialists, roastmasters, chefs and mixologists who aim to push themselves beyond the standards.



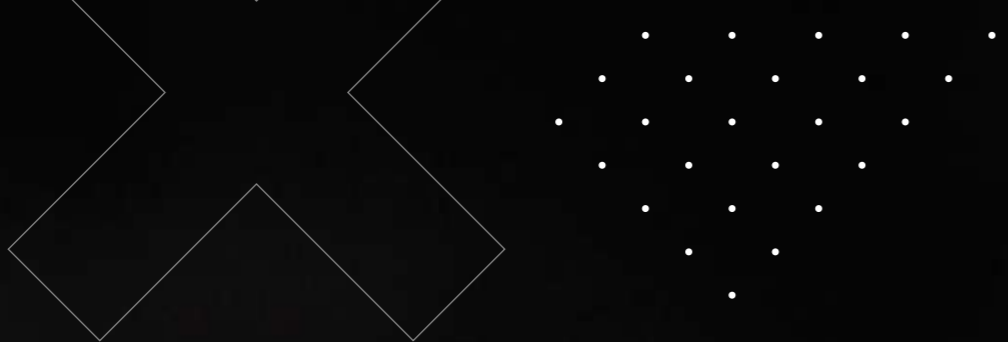

EVERYTHING AT YOUR TOUCH



The new 2.1" touchscreen display was designed to provide complete information about extraction, to be easy to read and to speed up every step of control and choice of setting.



Mode, recipe creation, temperature setting and energy saving: everything is readily visible and is adaptable for clarity and dynamic use. In particular, during the extraction phase, every selected variable is precisely specified to ensure real time control by the professional user.

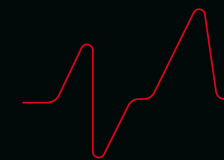



T3 GENIUS

Triple control for outstanding results

- T3 Genius technology guarantees temperature control of the steam boiler, the coffee boiler and the group for maximum precision in the cup. The E1 Prima Pro Brew Temperature Reproducibility has obtained optimal results with perfect positioning within the range laid down by World Coffee Events.
- T3 Genius technology guarantees even faster heating of the group compared to machines in the same category, with an increase in precision and reactivity. Additionally, it doubles the steam pressure and halves the quantity of water to produce a sweet and consistent milk cream.
- E1 Prima PRO increases productivity of the E1 Prima range and offers an excellent result in the cup, simply and quickly.

PUREBREW

The purest taste

Pure Brew Technology is an innovative extraction method that is applied to coffee and to the extraction of a new drink without using pressure. Pure Brew offers baristas a world of different recipes.

Pure Brew Coffee

PureBrew is the technology that's native to Victoria Arduino which, along with the new patented double mesh filter cone, provides the enjoyment of PureBrewCoffee, a filter coffee with unique characteristics, activated from the machine or the app with a simple switch. Every parameter [dose, volume and temperature] can be regulated by choosing one of the various water impulses profiles [light, medium and dark] to extract a high-quality coffee or tea in less than three minutes, with a consistent result.

Easy brewing

The genius of PureBrew technology lies also in its extreme simplicity of use: just set the water impulses profiles [light, medium or dark] and let the PureBrew algorithm work during the three phases of brewing for a fantastic new coffee experience.



Three extraction phases

There are three phases in the extraction time: the first, which is the same for every recipe, is the blooming phase for your coffee with a pause. The other two phases change according to the pulse cycles.

Three Pure Brew extraction profiles:

With the **light** profile, the impulses are frequent and very short, creating higher turbulence. With the **dark** profile, all impulses are longer with more contact time, so there is less turbulence. The **medium** profile is in between the other two.

PB TECH

PBtech for Espresso.

**PBtech reveals new flavours
in your espresso coffee.**

PBtech brings the best flavour balance and texture to your espresso cup. PBtech is an on/off espresso extraction technology that avoids any over-extraction of your coffee cake. It uses water pulses giving the coffee cake more space to expand, achieving a more balanced result in the cup in terms of aroma and flavours.

*PBtech can be activated
only when VIS technology is turned off.





ADVANCED STEAM BY WIRE

• • • • • •
• • • • • •
• • • • • •
• • • • • •
• • • • • •

Efficient steam in less time

With E1 Prima PRO the Steam-by-Wire system becomes Advanced, guaranteeing the same quality in terms of dry steam dispensing with 2.1 bar pressure and adding two controls to divide the steam for different capacity jugs.

Pressure up to 2.5 bar.

Accelerated power/speed ratio:
250g of milk heated in less than 18 seconds.

Bigger steam boiler than E1 Prima and E1 Prima EXP for higher productivity

Hot water wand with two different volumetric doses.

Easycream: automatic frothing of milk and plant-based drinks at the right temperature and with the right dose of cream.

Settings, use, programming: all in one app.

VIS is the exclusive Victoria Arduino AI-based virtual scale that speeds up the workflow compared to the previous version of E1 PRIMA.

VIS



A VIRTUAL INTELLIGENT SCALE

VIS is a Victoria Arduino technology developed to digitally estimate the right dose in the cup through algorithmic calculation. VIS brings improved workflow and the certainty of a great extraction making E1 Prima PRO an even better performing and smarter system.

HOW DOES IT WORK?

Set the desired weight in grams and VIS will automatically monitor the flow to obtain the right dose.

*VIS technology can be activated only when PB tech is turned off.



For correct VIS operation, Victoria Arduino suggests using specific filters provided with the E1 Prima PRO.

EASY AND FAST PROGRAMMING

Programming automatic extraction weighing is very easy and fast. Once the parameters have been set, just press a button.

INNOVATIVE

VIS is a totally digital system for constant monitoring of each dose. It is based on an AI algorithm developed by Victoria Arduino.

SUSTAINABLE DESIGN

In addition to reducing waste, VIS technology is implemented without the use of any additional components and without changing the design of the E1 Prima PRO.



“Unlock the full potential of coffee”



□ □ □ □ □ □ □ □ □ □

EMPOWERED DETAILS

Switch on in 7 minutes.

Direct connection for
continuous performance.

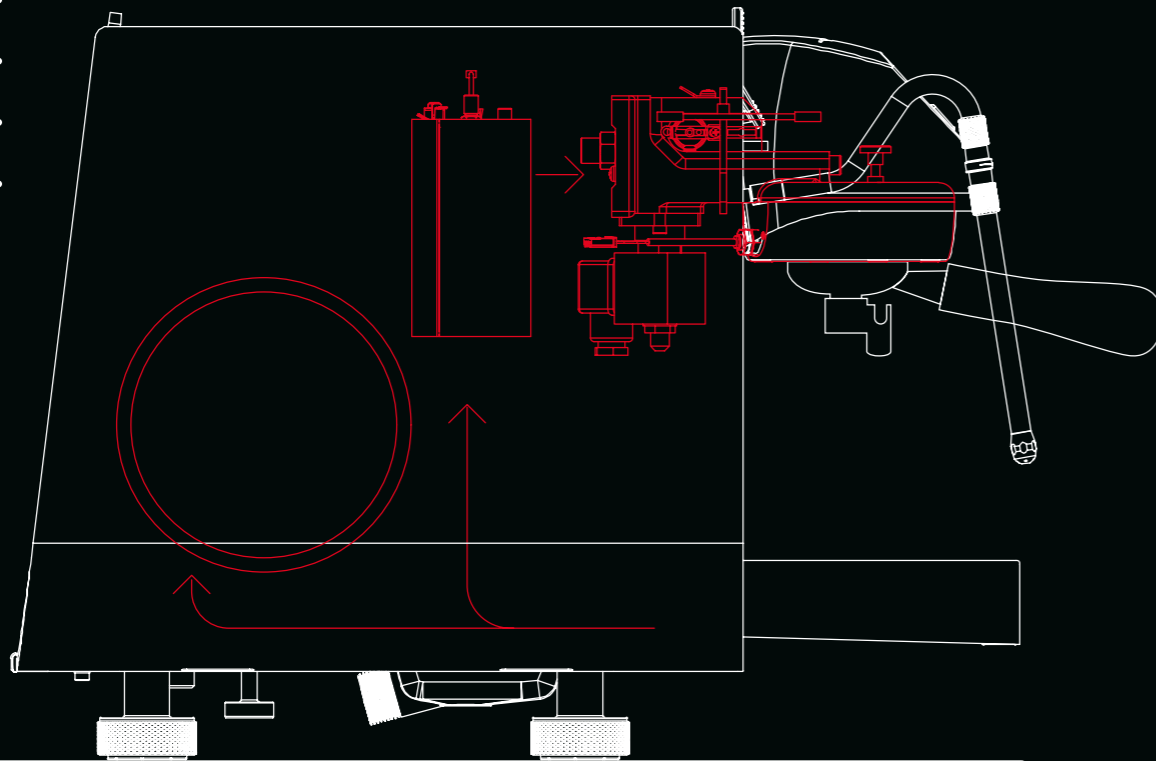

Coffee boiler expanded
to 0.6 litres. Even more
possible recipes.

Steam wand with two
dispensing levels for
different capacity jugs.

Partialized energy absorption
according to use [only coffee,
only steam, coffee and steam].

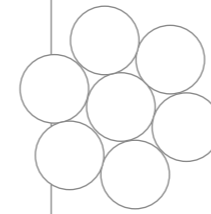

BUILT DIFFERENTLY

The group is lighter and more reactive and it requires less heat to work, thus reducing heating times and saving energy.

The insulated boilers increase thermal insulation thus avoiding waste and heat dispersion and increasing efficiency. Switching the machine on and off, apart from autopurge [automatic cleaning of the group], can be set from the app thus optimizing performance.

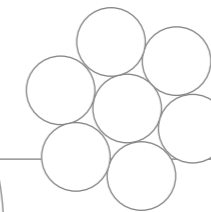



SMART COMMUNITY

The app connected to E1 Prima PRO is more than a simple intuitive interface.

After setting all the professional functions and creating your own recipes, this can be shared on Cloud Recipe, a space where taste pioneers from all over the world can meet and use as a source of inspiration. It's also an efficient tool for communicating with your followers.

The Victoria Arduino coffee specialist community extends to wherever there is passion.

**DOWNLOAD
VICTORIA ARDUINO
E1 PRIMA APP ON**





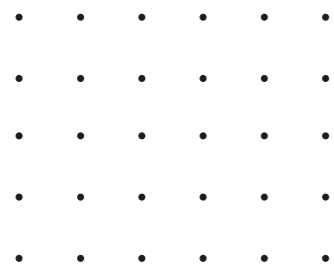

COLOUR PALETTE



BLACK MATT



SHINY

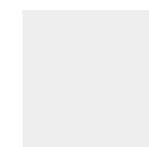

WHITE MATT



STANDARD



BOLD BLACK



RACING RED



E1 PRIMA PRO



Details

○	Version	PRO
●	Steam boiler capacity	1,8lt
●	Coffee boiler	0,6 lt
●	Espresso technology	T3 Genius
●	PureBrew technology	included
●	PB Tech	included
●	Steam-by-Wire	advanced
●	Easycream	optional
●	Tank and direct connection	direct connection only
●	PureBrew filterholder	included
●	Hot water	2 settings
●	Display	touchscreen

Dimensions

Width	410 mm
Depth	510mm
Height	380mm
Cupwarmer	330 x 280 mm
Group height	95 mm
Power	min 2000W/ max 3100W

One line. One group. Three kinds of passion.

EJ PRIMA



Versatile&Eclectic

The original: Victoria Arduino quality, wherever you want.

EJ PRIMA EXP



Lifestyle Explorers

The pleasure of discovering Pure Brew.

EJ PRIMA PRO



Alongside Pioneers

The new frontier of professionals.

E1 PRIMA

One line. One group. All you ever wanted.



PRIMA

Group number	1
Steam boiler capacity	1,5lt
Coffee boiler	0,14lt
Boiler insulation	included
Espresso technology	NEO technology
PureBrew technology	not included
PB Tech Prima	not included
Steam-by-Wire	included
Autopurge	included
Economizer	included
Cool touch	included
Easycream	optional
Tank and direct connection	included
Stainless steel filterholder	included
Stainless steel pavillon	included
Showerhead reinforced	included
PureBrew filterholder	not included
Hot water	2 settings
Display	ghost display
Rear and interior lights	included
Raised feet	optional
Bluetooth	included
Wi-Fi module	included
App	included

Structure	stainless steel
Side panels	aluminium
Front side	aluminium
Back side	aluminium

Dimensions

Width	410mm
Depth	510mm
Height	380mm
Cupwarmer	330 x 280mm
Group height	95mm
Power	min 1800/ max 2600W

EXP

Group number	1
Steam boiler capacity	1,5lt
Coffee boiler	0,14lt
Boiler insulation	included
Espresso technology	NEO technology
PureBrew technology	included
PB Tech Prima EXP	not included
Steam-by-Wire	included
Autopurge	included
Economizer	included
Cool touch	included
Easycream	optional
Tank and direct connection	included
Stainless steel filterholder	included
Stainless steel pavillon	included
Showerhead reinforced	included
PureBrew filterholder	included
Hot water	2 settings
Display	ghost display
Rear and interior lights	included
Raised feet	optional
Bluetooth	included
Wi-Fi module	included
App	included

Structure	stainless steel
Side panels	aluminium
Front side	aluminium
Back side	aluminium

Dimensions

Width	410mm
Depth	510mm
Height	380mm
Cupwarmer	330 x 280mm
Group height	95mm
Power	min 1800/ max 2600W

PRO

Group number	1
Steam boiler capacity	1,8lt
Coffee boiler	0,6lt
Espresso technology	T3 Genius
PureBrew technology	included
PB Tech Prima PRO	included
Steam-by-Wire	advanced
Autopurge	included
Economizer	included
Cool touch	included
Easycream	optional
Tank and direct connection	direct connection only
Stainless steel filterholder	included
Stainless steel pavillon	included
Showerhead reinforced	included
PureBrew filterholder	included
Hot water	2 settings (cooltouch wand)
Display	touchscreen
Rear and interior lights	included
Raised feet	optional
Bluetooth	included
Wi-Fi module	included
App	included

Structure	stainless steel
Side panels	aluminium
Front side	stainless steel
Back side	aluminium

Dimensions

Width	410mm
Depth	510mm
Height	380mm
Cupwarmer	330 x 280mm
Group height	95mm
Power	min 2000/ max 3100W





Victoria Arduino

INSPIRED BY YOUR PASSION.

victoriaarduino.com/eagleoneprima

